

# MR MARBLE WALL PANEL INSTALL Guide

Concord, ON

(866) 566-3581

Fax: (905) 760-2395

[www.mrmarble.com](http://www.mrmarble.com)

The tips and hints on this page are compiled from years of experience and the recommendations of professionals to help you do a perfect job of installing your Wall Panels and Accessories

## 1 Panel Installation Order

When there is a ceiling panel, the ceiling panel should be installed first. The back panel is installed next and the side panels are installed last.

Keep in mind that each wall panel has only one or two finished edges and the rest are unfinished cut edges. Panels must be installed so that the smooth finished edges will be showing.

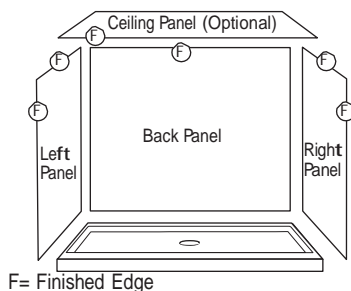

F= Finished Edge

Onyx Panels can be installed onto sheetrock (water resistant is preferred), HardiBacker, concrete board, and any similar wallboard material. If using any type of concrete board, priming the wallboard will be necessary to help the silicone adhere, especially if the wallboard is "dusty" by nature. When installing onto sheetrock, priming is recommended. However, it is not good to apply the final coat of paint before installing the Onyx wall panels as some paint finishes do not allow the silicone to adhere correctly to them.

## 2 Dry-Fitting & Inspecting

Identify, inspect, and dry-fit the wall panels. It may be necessary to remove the plastic to properly inspect the wall panel. Do any necessary trimming of the panels before applying any adhesive. For the back panel, there should be about 1/8" of clearance on each side to allow for expansion. This clearance will be covered by the side panel. Side panels are sent 1/8" taller than the back panel to allow for exact sizing. Side panels should fit tightly against the back panel to allow for minimal glue.

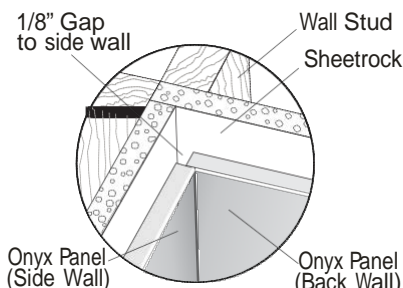

During installation, if it becomes necessary to bend a panel, warming the panel will reduce the risk of the panel cracking when it flexes. When dryfitting, avoid sliding the panel on the shower base. Lifting the panel into place will reduce the chance of scratching the base. Side panels are sent 1/8" tall to allow for exact on-site sizing.

## 3 Cutting

For trimming, shaping, drilling, or cutouts, use standard wood cutting tools such as jig saws, circular saws, drill bits, and belt sanders. Fine to medium tooth finish blades work best for cutting.

Make faucet holes with an electric drill and a normal hole saw bit or by using a jigsaw or circular saw.

Belt sanders work well for an exact fit.

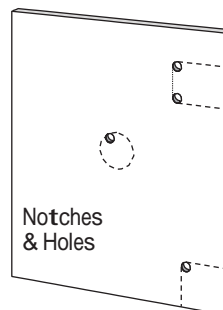
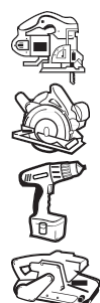

All cut-outs for notches or accessories should have rounded corners (sharp corners can cause stress cracks). Rounded corners can be made by drilling 1/4" or larger holes at the corners of the openings and then cutting between holes with a jigsaw. (see sketch)

For steam showers, maintain a 1/2" or more clearance between the steam jet and the Onyx panel. Also, steam jets or diverters must be 8" or more from the Onyx base or another Onyx wall.

## 4 Silicone Adhesive

4.1) Apply Silicone Adhesive to Panel (or Wall) in 2" diameter rings, 3/8" thick, positioned about 8" apart (see sketch).

4.2) Run another bead along the perimeter of the panel (or the wall board) about 1" in from the edge. This bead will help support the area along the edge of the panel between the silicone rings.

4.3) Press the panel against the wall. The rings will flatten out and act like suction cups. Separating the Panel a couple of inches from the wall for about 1 minute and then pressing it back again (webbing) will make the adhesive set more quickly. Bracing may be needed while silicone cures.

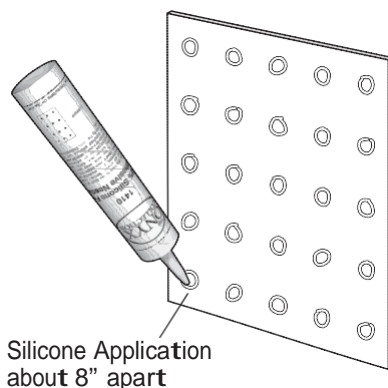

For best results, Use Adhesive Silicone from The Onyx Collection which is specially formulated to provide maximum adhesion and proper cure rate.

You will need one tube of adhesive (10.3 oz) for every 1,000 square inches, or 6-10 tubes for an average shower.

For steam shower wall panels, apply extra adhesive silicone to the areas near the steam outlets.

## 5 Caulking Seams

Use 100% silicone for all seams between wall panels, between panels and the base, and around any accessories and trim.

Note: where the edges of the wall panels meet the drywall, you can use painter's tape on the drywall and then apply a small bead of color silicone to the small gap (silicone can not be painted so it is important to not get any silicone on the drywall).

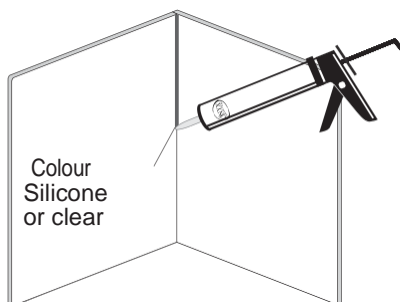

To help clean up any excess silicone, have a bottle of Rubbing Alcohol and a roll of paper towels available.

Also, if you use your finger to smooth the silicone bead, dampening your finger with the rubbing alcohol will help make a smooth bead and also reduce smearing.

# MR MARBLE WALL PANEL INSTALL Guide

Concord, ON

(866) 566-3581

Fax: (905) 760-2395

[www.mrmarble.com](http://www.mrmarble.com)

## 6 Installing Recessed Shower Caddies

If you are installing a recessed Soap or Shampoo Caddy, keep track of the locations of the wall studs so there is not a conflict when cutting the hole for the caddy.

Cut holes for recessed caddies after the panel is installed and fully supported by the wall.

Each recessed caddy includes instructions and a template for the exact cut-out needed.

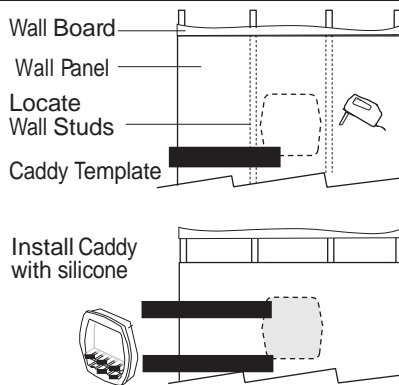

Always check for stud location before cutting the panel. If there are no studs in the intended area for the caddy, but the exact stud location is not known, begin with a small hole and then measure over to the stud for the exact location.

## 7 Mounting Shower Doors and Shower Accessories

Follow the mounting instructions that come with each accessory.

When drilling holes in the Onyx Wall Panel, always make the hole slightly larger than the fastener in order to avoid stress on the panel.

If anchors must be used because the screw location cannot be aligned with a wall stud, make the clearance hole in the Panel large enough for the head of the anchor to fit through so it can anchor securely into the wall board behind the panel. (see sketch)

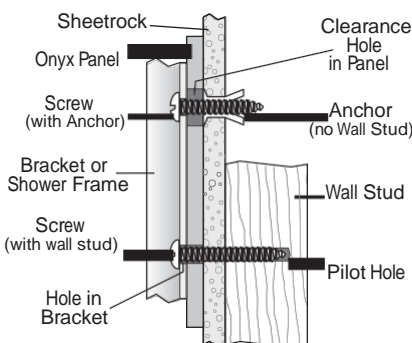

Clearance holes through the Wall Panels are very important. Fasteners should pass through a clearance hole in the Panel and never screw directly into the Panel. Always secure fasteners to anchors or wood backing as seen in the sketch.

## Other Helpful Suggestions & Solutions

What to do if a panel is not flat:

If a wall panel has a bend in it, it can be flattened by simply laying it on a flat surface overnight.

To flatten the panel faster, gradually apply a little weight and/or heat (normally heat is not necessary, but if it is, an electric blanket or hair dryer will work well). The panel should flatten within a few minutes.

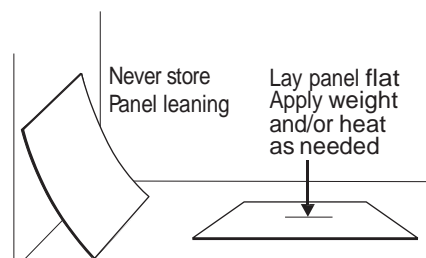

Cutting or Notching Panels:

Always put a radius on the inside corner when notching a panel. The rounded corner will greatly reduce the chance of the panel cracking during installation.

In cooler temperatures, use extra caution when cutting and notching panels because the panels do not flex as well when cold. Warming the panel will make it more flexible and easier to install.

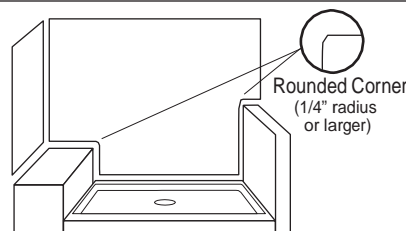

Panel Care During Installation:

Panels are packaged with a protective plastic wrap on them. Leave this wrap on the panel until the panel is ready to be installed (after all sizing and trimming is completed) to help avoid scratches. When cutting the panel, protect the finished side of the panel with cardboard or painter's tape to keep the saw from scratching the panel.

## Cleaning and Care

Your MrMarble products can be cleaned using almost any liquid household cleaner (except those that have abrasive particles in them which can scratch the material surface). We suggest a cleaner and surface protector (GelGloss® and BonAmi®), but most quality cleaning products you can buy locally will work well. After cleaning, use Gel Gloss® to make future cleaning easier. For heavy cleaning, a soft brush can be used.

Also, ventilation is important to help reduce water spots and mineral deposits, so keep doors open when possible.

